

Fabrication des marionettes

Matériel nécessaire

- _ Un tube de colle
- _ Une paire de ciseaux
- _ Les 5 fiches personnages imprimées en recto (A4 paysage)
- _ Un crayon papier ou stylo par personnage

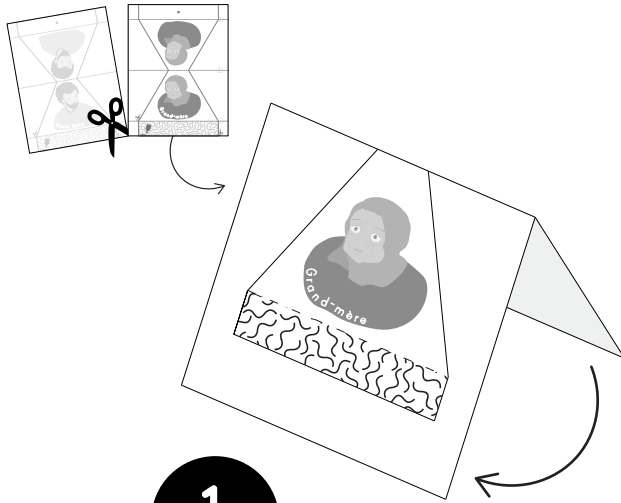

1

Plier en deux le long des pointillés

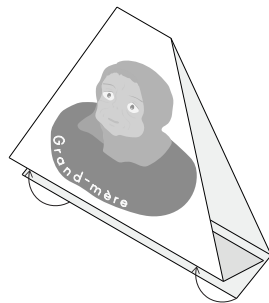

4

Plier et rabattre les languettes le long des pointillés de manière à les coller ensemble

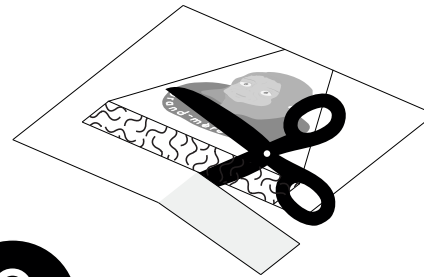

2

Découper le long des lignes

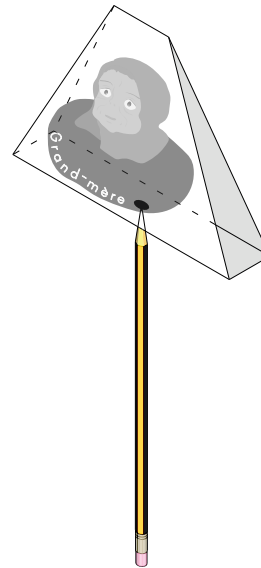

5

Percer le papier avec la pointe d'un crayon, au niveau du point noir

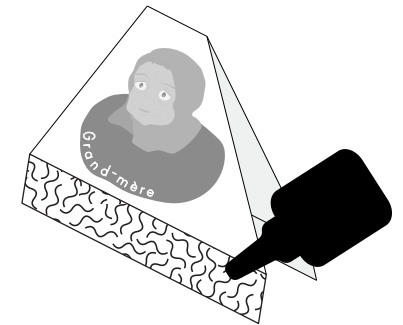

3

Coller la face hachurée

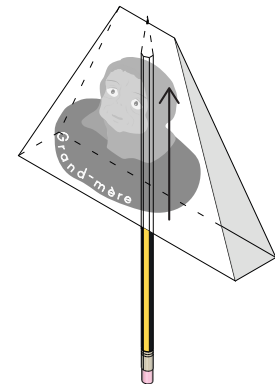

6

Glisser le crayon et percer de nouveau sur la tranche de papier plié

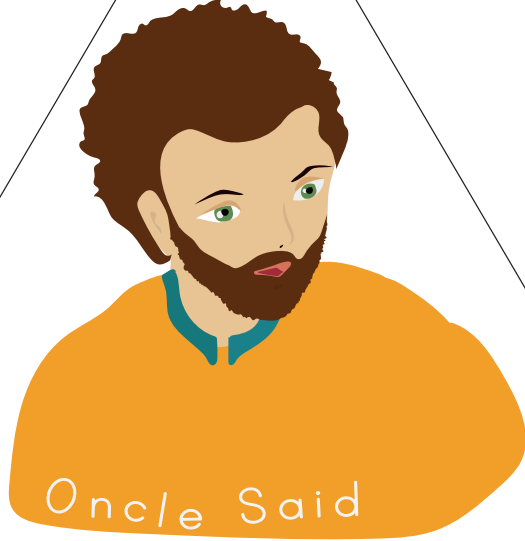
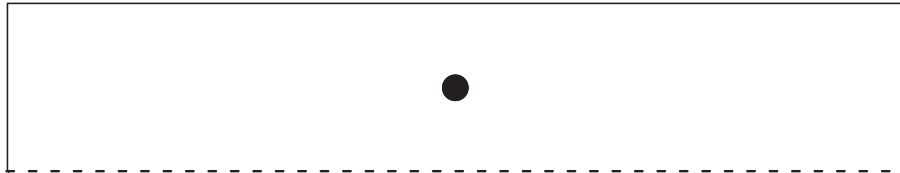

Oncle Said

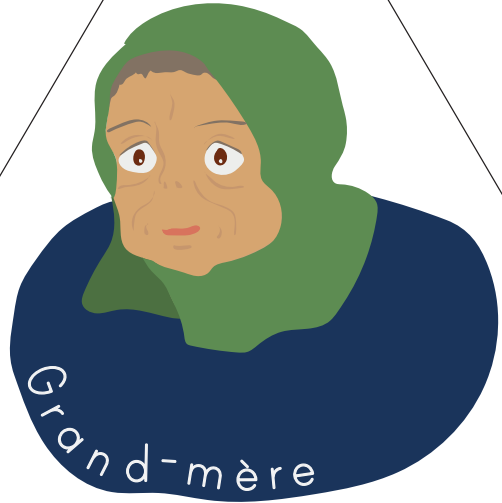
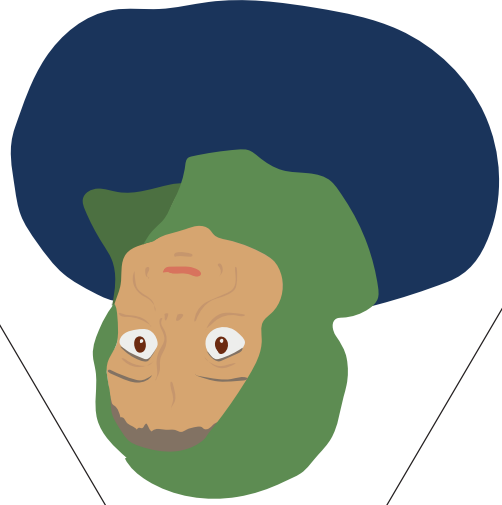
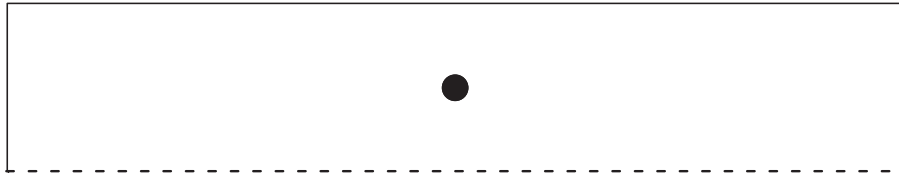
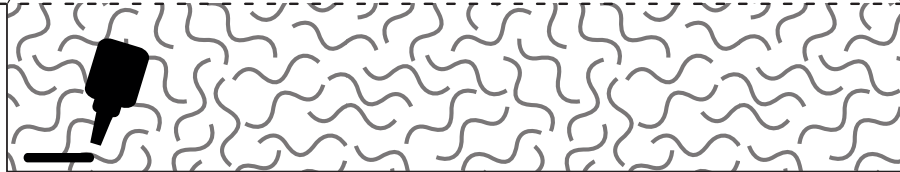

Grand-mère

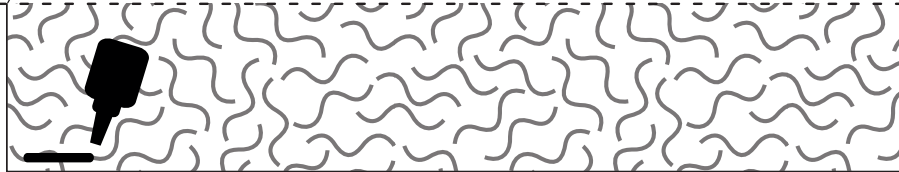

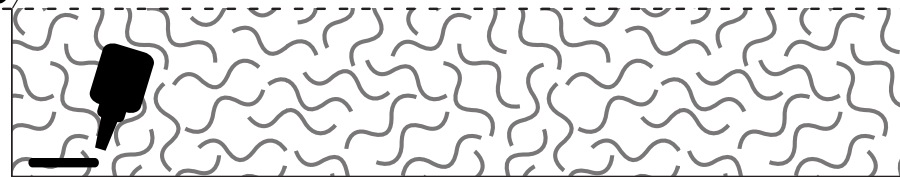
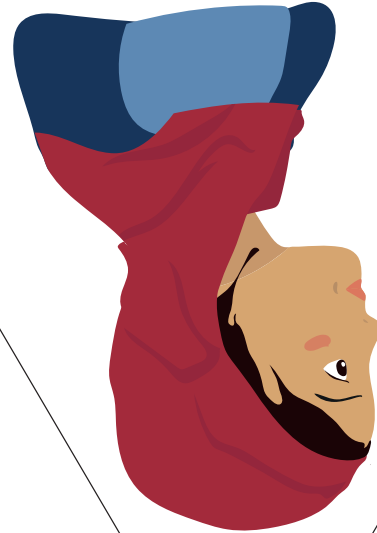
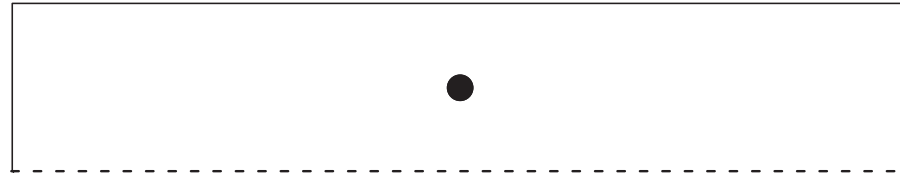
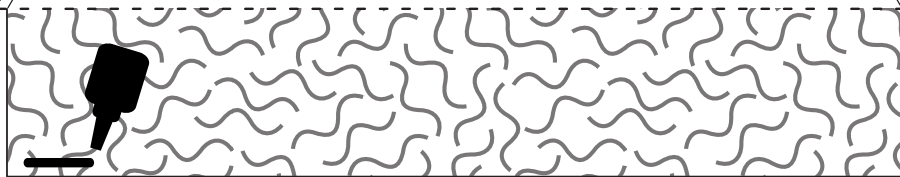
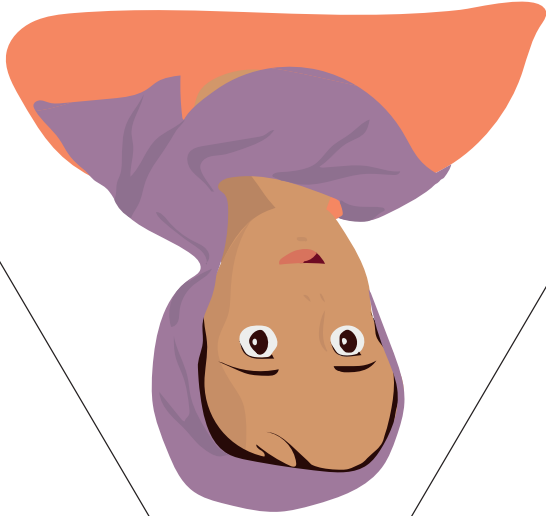
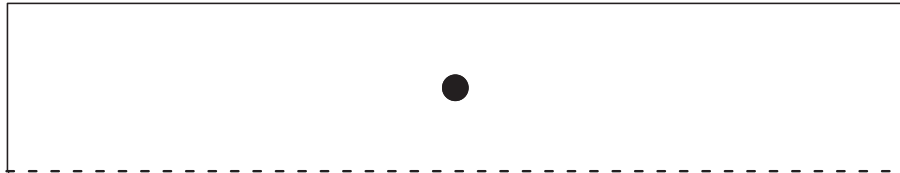

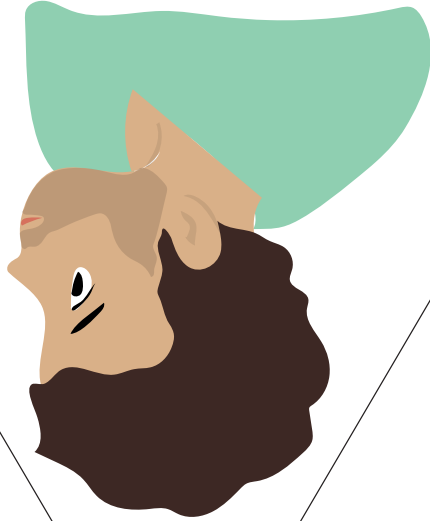
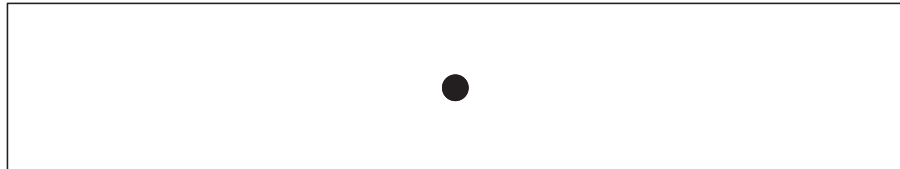

Le père

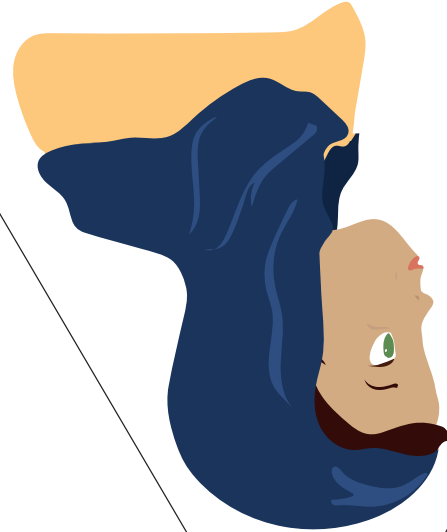
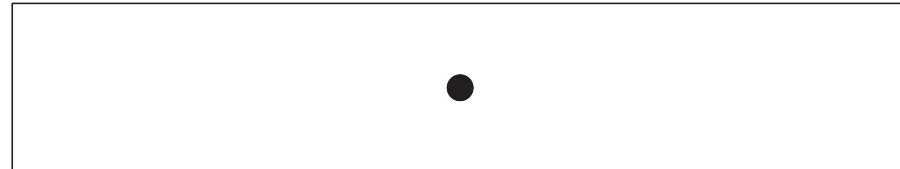
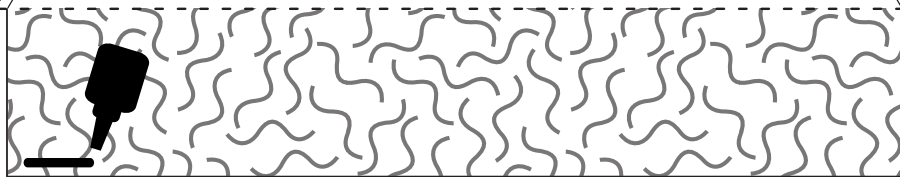

Tante Salima

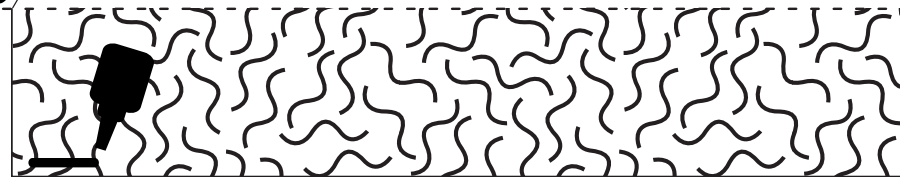

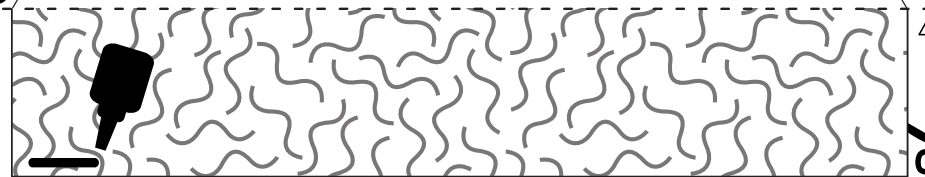
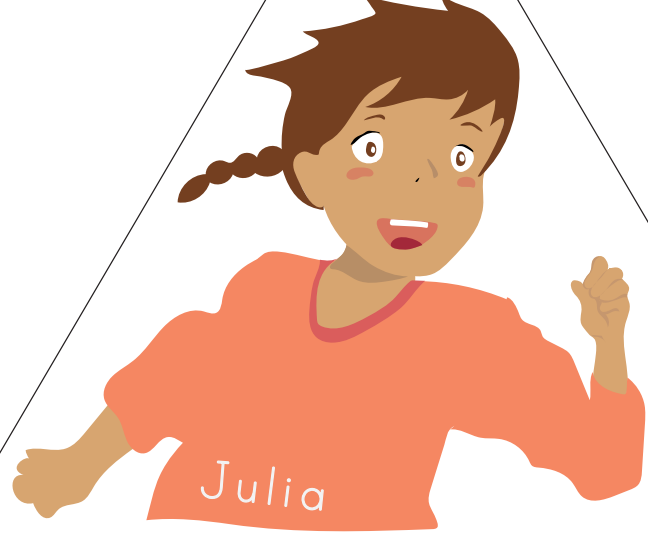
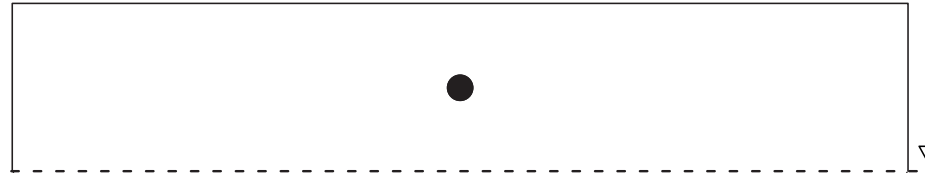
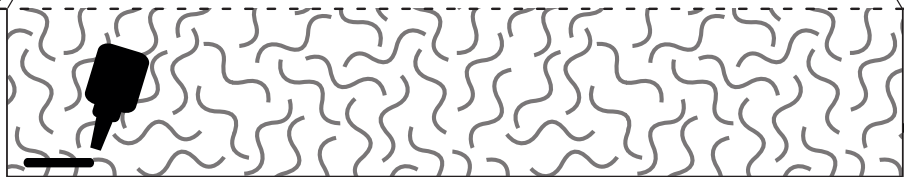
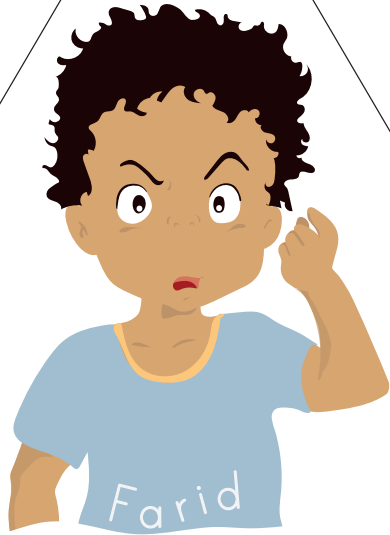
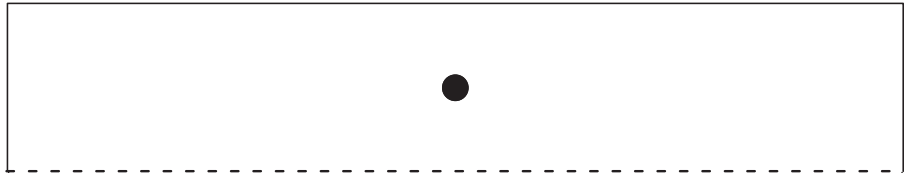

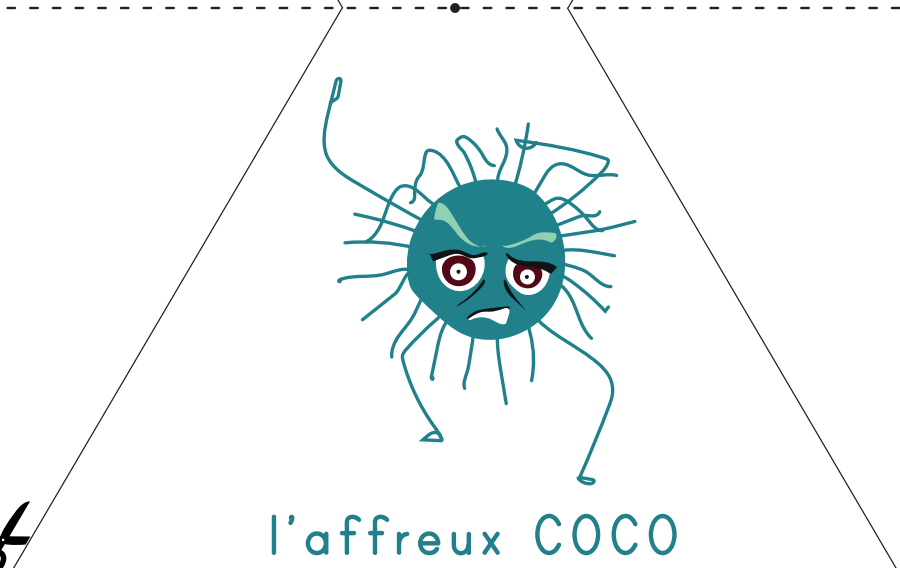
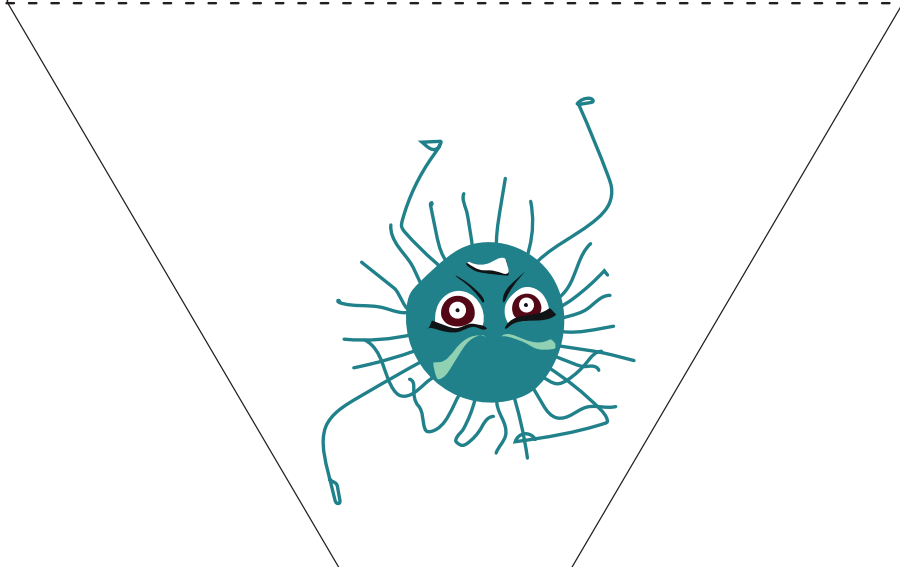
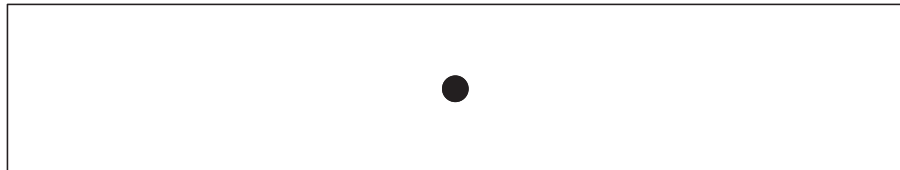

l'affreux COCO

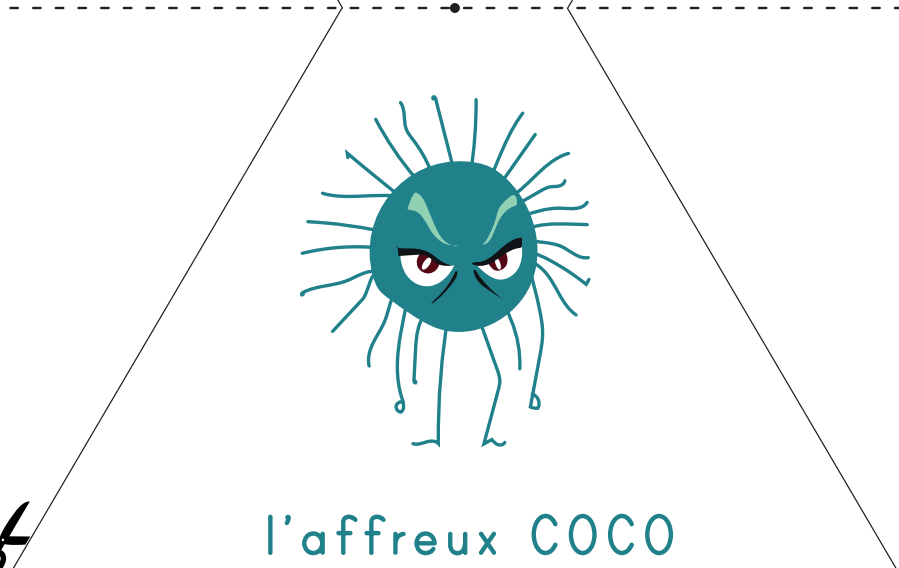
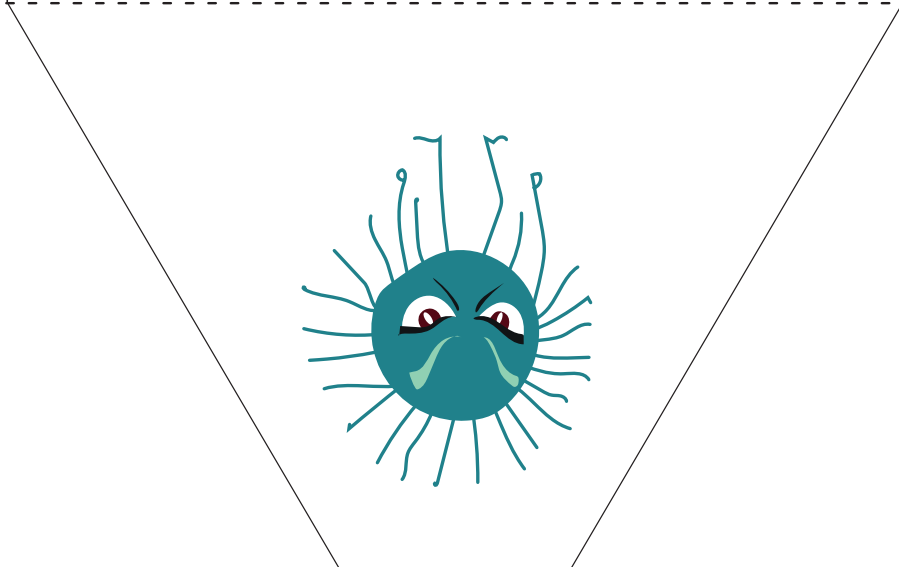
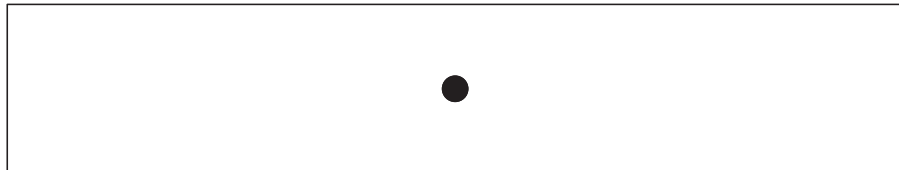
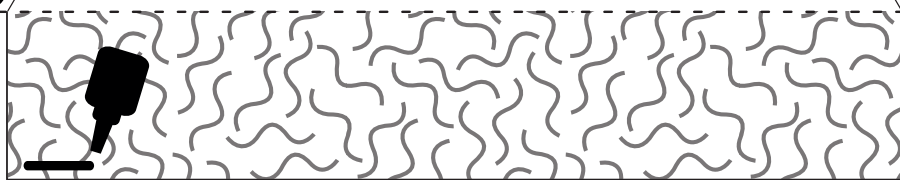

l'affreux COCO

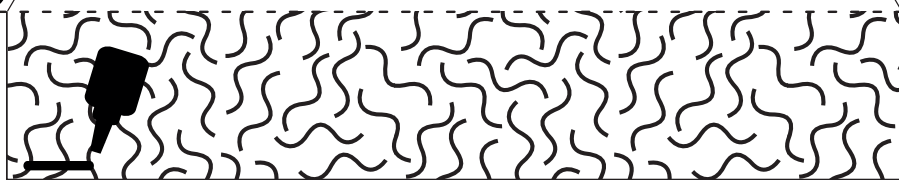

Fabrication du décor

Matériel nécessaire

- _ Un tube de colle
- _ Une paire de ciseaux
- _ Les 2 fiches paysage imprimées en recto (A4 paysage), en papier épais

1

Découper le long des lignes

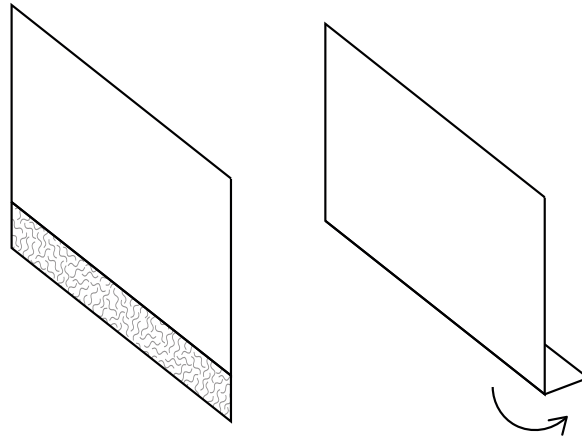
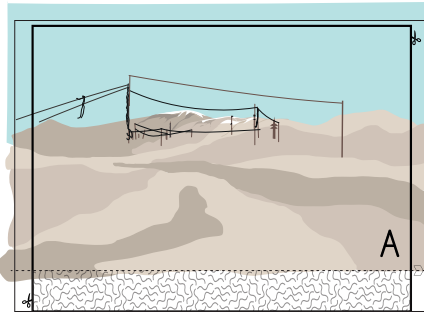

2

Plier le long des pointillés

3

Disposer les paysages l'un derrière l'autre pour créer le décor de votre théâtre de marionettes

